

DrayTek

Business and Home Networking Solutions



Index

What DrayTek Commit	2-6
Centralized Management System	7-9
Network Traffic Analyzer	10
Business Solutions	11-19
Fiber	20-24
Broadband Series	25-31
VigorIPPBX	32
VDSL2	33-35
ADSL2/2+	36-39
WLAN Access Point	41-43
Ethernet Switch	44-45

DrayTek, state-of-the-art firmware designer and quality hardware producer is the reliable supplier of novel networking & telecommunications for SOHO and SMB. At present, DrayTek's solutions, ranging from enterprise-level firewalls, mission-critical bandwidth management and comprehensive VPN facilities, triple play routers, to prospective IP PBX solutions, can meet the market trend and go above and beyond customer's expectations.

Customer Services enhanced by MyVigor Portal

Serving activation of followings

- DrayTek Anti Virus license
- DrayTek VigorACS SI license
- Kaspersky Anti Virus license
- Commtouch Anti Spam license
- Commtouch GlobalView Web Content Filter
- BPJM Web Content Filter
(hosted by DrayTek GmbH)

Membership/Customer Survey

IPv6 Commitment



Broadband Connectivity changes your life

How many applications can be available for the Households?
Mutli-media streaming, High-Definition IP TV, Parent Control.

What does the Home Office expect? *Speed* !!!

Protection from Internet threats. Reduce network overhead.
Everything encrypted for remote access and VoIP.

What do IT Pros and SMB resellers must deliver to SMB?

CSM, URL Filtering, Application Blocking

Enhance Productivity.

Multi-protocol VPN, DoS Prevention, SPI Firewall

Secure Remote Access. Strengthen Security.

IEEE 802.11 Wi-Fi, Multiple SSID

Reliable and secure wireless access to the network.

Bandwidth Management and Quality of Service (QoS)









Assure mission-critical data be delivered with high priority.

Assure the VoIP packet be crystal-clear.

Load-balancing and Failover

Maintain Business Continuity of E-mail, VoIP, and other cloud services

Broadband

	Vigor3900	Central Site VPN Gateway for medium-size businesses
	Vigor2960	Dual-WAN Security Firewall
	Vigor/PPBX 3510	Security Router with IP PBX
	Vigor3300V plus	MultiWAN with VoIP
	Vigor3200	MultiWAN
	Vigor2920Vn	Dual WAN with VPN/Firewall
	Vigor2130Vn	Gigabit WAN for home multimedia
	Vigor2110Vn	Broadband Router for DSL modem
	VigorFly 210	Ideal for 3G/WiMAX/LTE



VigorACS SI
Centralized Management system

VDSL2



Vigor2850Vn

VDSL2 Security Router



Vigor2760Vn

VDSL2 IAD

ADSL2+



VigorIPPBX 2820

ADSL2+ Security Router with IPPBX



Vigor2830Vn

Giga WAN/LAN High-integrated service router



Vigor2820Vn

ADSL2+ Security Router for professionals



Vigor2710Vn

IAD for SOHO



Vigor2710ne

IAD for home



VigorAP 800

PoE WLAN Access Point with Dual LAN



VigorACS SI

Centralized Management System

VigorACS SI

Centralized Management System

TR-069
Management System
for Vigor series routers



Essentials

Networks and Devices

Wholenetwork (84)

- uknetwork (1)
- itnetwork (11)
- tknetwork (9)
- usanetwork (0)
- gmnetwork (0)
- bmnetwork (4)
- mxnetwork (6)
- amnetwork (2)
- gmnetwork (0)
- plnetwork (3)
- mbnetwork (6)

Wizards

Reports

Inventory Monitor

Search Device

Network: Wholenetwork

Your reliable networking solutions partner

Network View VPN

Networks And Devices

Managed networks and devices

Total number of networks:25
 Alarm networks:8
 Total number of devices:3
 Number of alarmed devices:3

Unknown Devices

IP Address	Device Name	Device Type	Action
189.146....	V5510 MEX	VigorPro 5510	
77.52.3....	DrayTek_005...	Vigor2910VG	
140.137....	DrayTek_005...	Vigor2950 Serie...	

Latest Alarms

Level	Time	Device Name	Network	Description	Action
Critical	Sun Jul 17 08:54:2...	V5510 MEX	Wholenetwork	DeviceLossConnection	
Critical	Sat May 28 00:40:5...	DrayTek_00507F_V...	Wholenetwork	DeviceLossConnection	
Critical	Sat May 28 00:40:5...	DrayTek_00507F_V...	Wholenetwork	DeviceLossConnection	



Device



Alarm



Log



Provision



Admin



User



Help



Logout

Multi-site Central Management

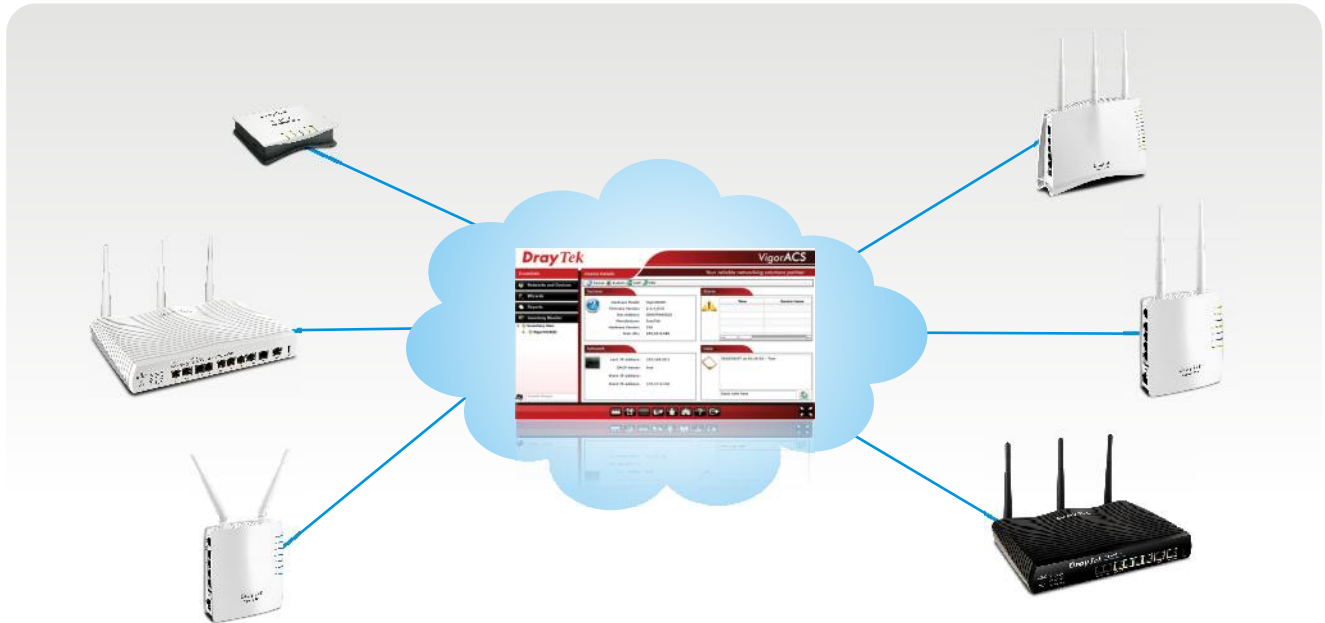

- Centralized configuration and monitoring of network devices
- TR-069 based Auto Configuration Server
- Automated Drag & Drop feature for VPN connections
- Locations shown on Google Map
- Alarm Records

acs.draytek.eu

Network Traffic Analyzer

DrayTek

98 Users Logged 1 Admin Online Admin

Smart Monitor

System User Setting Service Analysis User Analysis Report

Manual Refresh

Quick Start Guide

- > Create your **Admin Account**
- > Modify general **Setting**
- > Create **Group/Department** to manager **users**
- > View **service records** and traffic in **Service Analysis**
- > View each **user's records** and traffic in **User Analysis**
- > View statistics and analysis information in **Report**

Protocol	Total	No.	IP Address	User Name	Group/Department	To
FTP	11.38 MB	1	192.168.2.145			11.59 MB
HTTP	5.89 MB	2	192.168.3.162			5.36 MB
ICQ	0.00 MB	3	192.168.2.32			2.50 MB
MSN	0.00 MB	4	192.168.2.231			2.43 MB
P2P	0.00 MB	5	192.168.2.177			382.83 KB
POP3	0.00 MB	6	192.168.3.199			349.15 KB
SMTP	0.00 MB	7	192.168.2.204			322.21 KB
TELNET	0.00 MB	8	192.168.2.209			256.83 KB
WEBSMTP	0.00 MB	9	192.168.2.85			253.69 KB
YMSG	0.00 MB	10	192.168.2.248			240.28 KB

Tricks & Tips

- > Admin Online
- > Event Log
- > Resources
- > Service Top 10
- > UserTop 10

User Analysis

- > Personal Records & Report
- > Users' Traffic of each protocol
- > Individual Top10

Service Analysis



FTP



Mail



HTTP



IM



Telnet



P2P



Webdown



Stock



Game



SIP



DNS Query



VPN

Statistics & Report

- > Each Service traffic graph
- > Hard Disk utilization graph
- > Generate offline PDF reports, send daily report email

working with

Vigor
2820

Vigor
2830

Vigor
2920

Vigor
2930

Vigor
2950

Vigor
2955

Vigor
3200

VigorPro
5510

Business Solutions



Mid-size business

Vigor3900

Central Site VPN Gateway



- Giga WAN
- Fiber (WAN)

Vigor3900

- Four Gigabit Ethernet WAN ports
- Gigabit SFP Module WAN port
- Gigabit SFP Module LAN Port
- Two Gigabit Ethernet LAN ports
- Up to 500 simultaneous IPSec/PPTP/L2TP Tunnels
- WAN Load Balancing & WAN Failover
- VPN backup
- High Availability
- User Management
- Native IPv4 & IPv6 support
- Professional Firewall & QoS
- 802.1q Tagged and port-based VLANs
- Multiple LAN-side private IP subnets

Central Management/VPN & Security

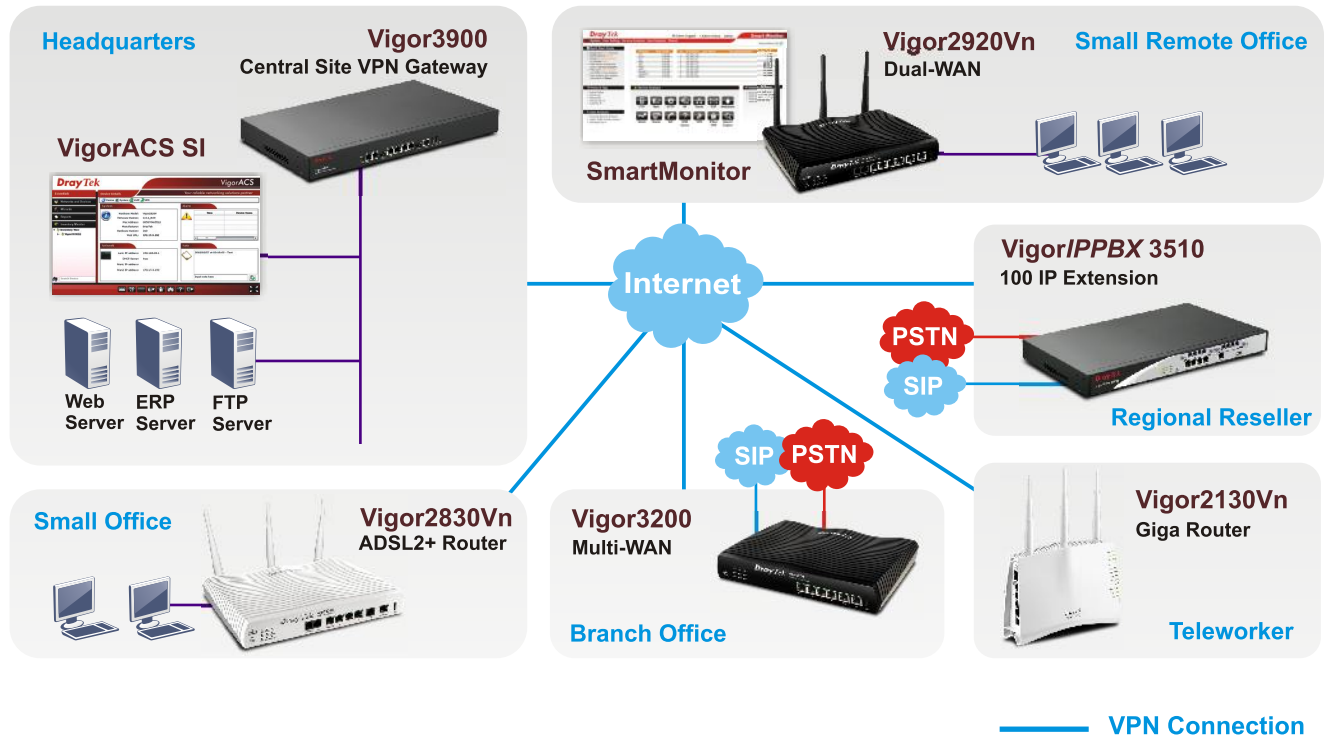

Vigor2960

Dual-WAN Security Firewall



- 200 VPN Tunnels

Vigor2960

- Gigabit Ethernet WAN ports
- Gigabit Ethernet LAN Port
- Up to 200 simultaneous IPSec/PPTP/L2TP Tunnels
- WAN Load Balancing & WAN Failover
- VPN backup
- User Management
- Native IPv4 & IPv6 support
- Professional Firewall & QoS
- 802.1q Tagged and port-based VLANs
- Multiple LAN-side private IP subnets

Robust Firewall with User Management Feature

The User Management feature allows admin to make different level of authentication to different users groups.

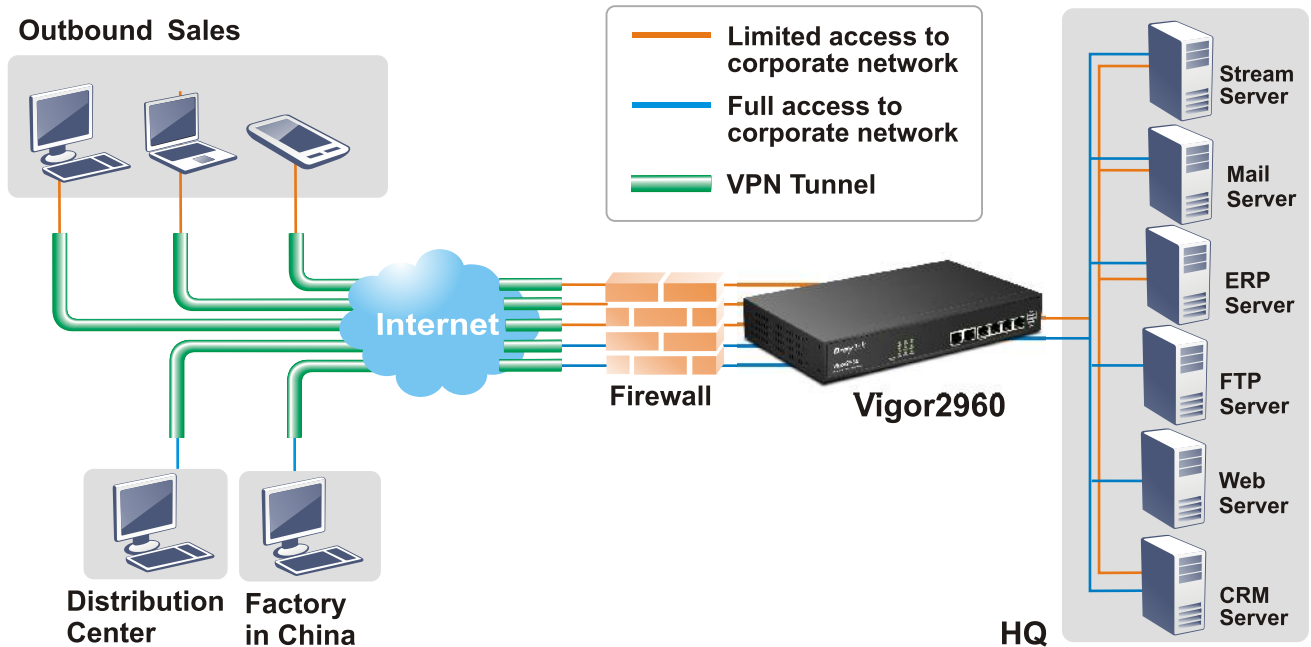

Vigor3200 Series

Multi-WAN



- 4 Ethernet WAN + 1 USB WAN

Multi-WAN Load Balancing/Failover

- QoS & Firewall
- 64 VPN Tunnels

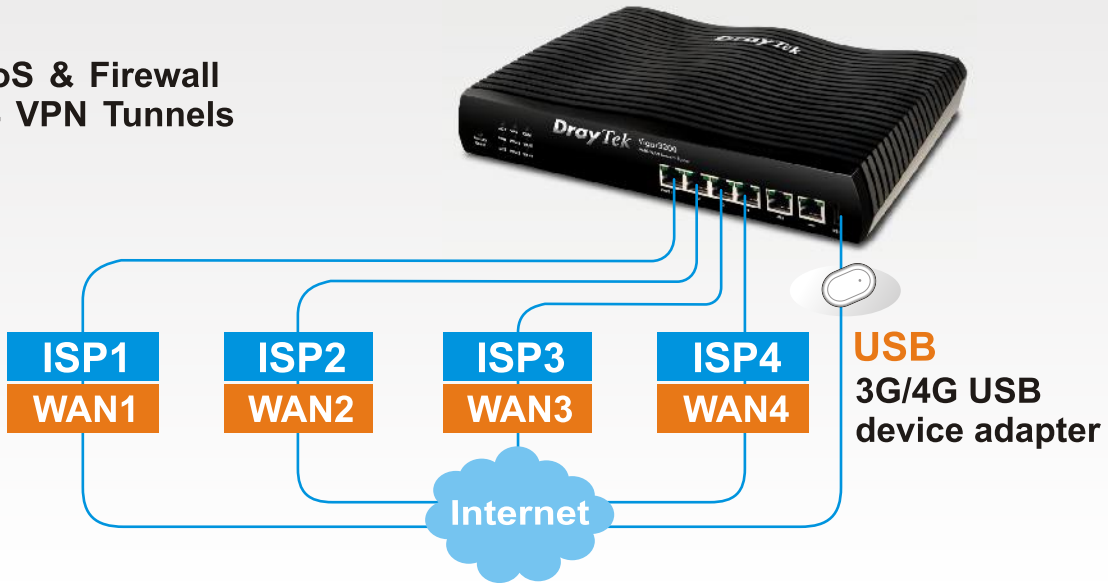



FTTx
FTTx

Vigor1000 Series

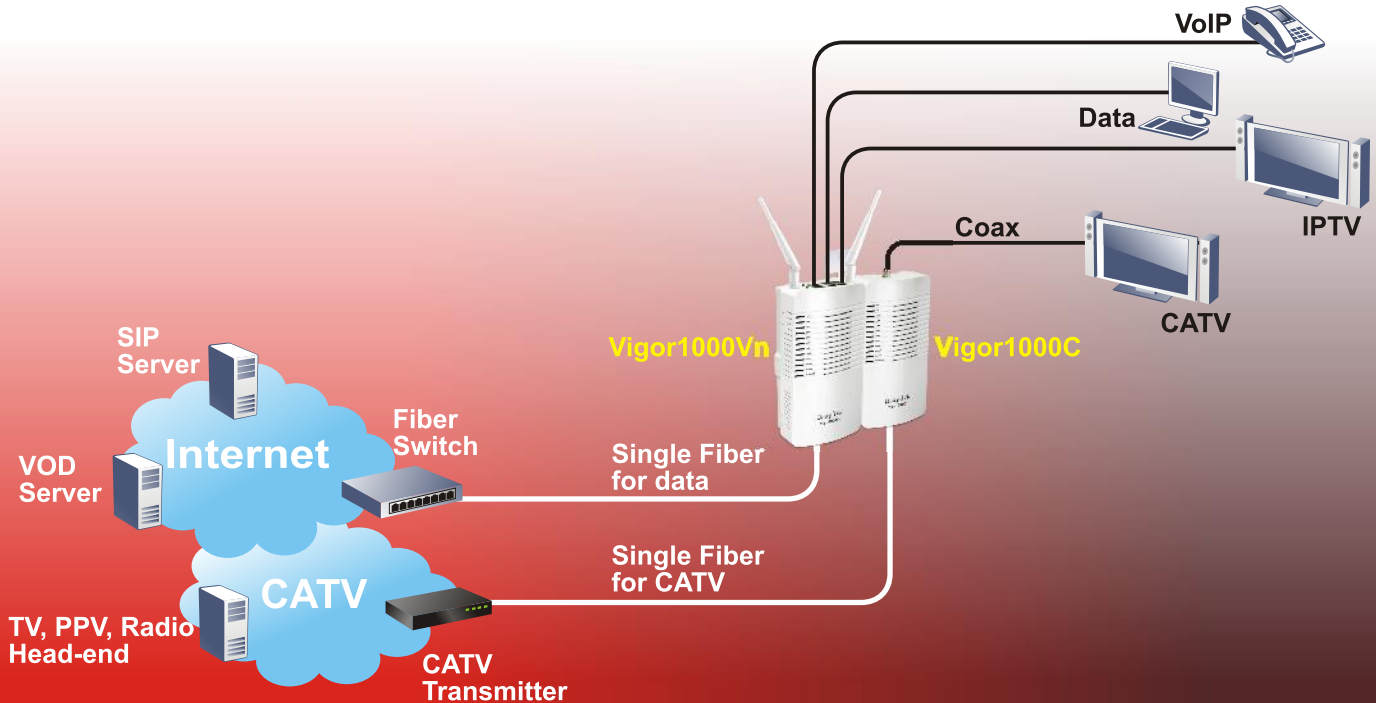

Vigor2920F

Fiber Router



Vigor2110F Series



Vigor2130F Series

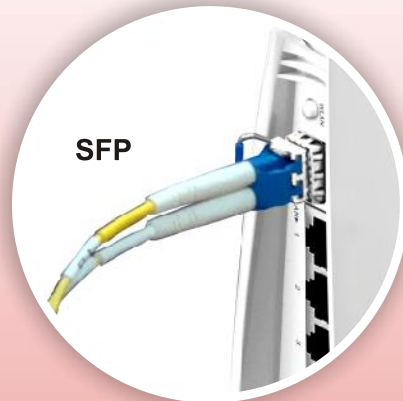

VigorFly 210FV

Fiber Router



Broadband for SOHO

- Your Internet Service Provider already provided you with a xDSL/cable modem.
- You connect DrayTek VPN/Firewall router to the said existing router.



Broadband Access Today

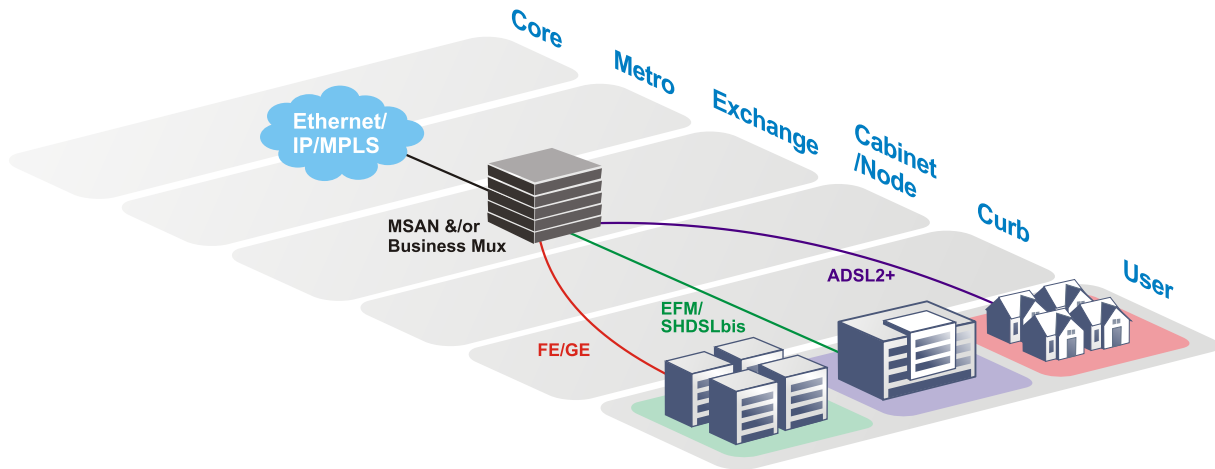

VPN backup

SPI Firewall

Session Limitation

Dual WAN or Multi WAN Load-balancing/ Failover

QoS

Priority of Traffic

Rate Limitation

Bandwidth Management

URL Filtering

Central Management

Multi-Subnets (Multiple LAN-side private IP subnets)

Content Security Management

SSL VPN

VLAN Prioritisation & 802.1q

VPN load-balancing

Application Blocking

Vigor2920 Series

Dual-WAN Router

• 32 VPN Tunnels

Security & Firewall
Multi-WAN Load Balancing/Failover

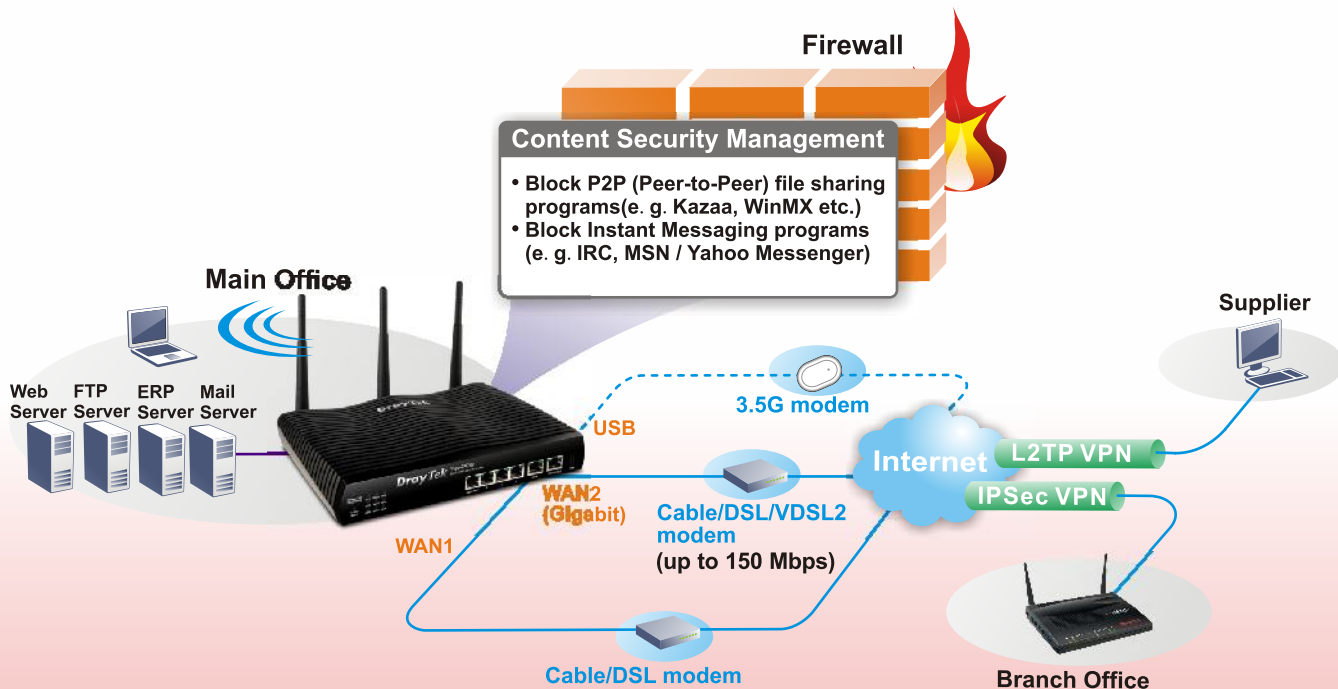

Vigor2130 Series

High Speed Gigabit Router

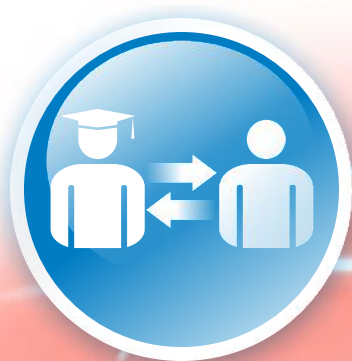

**Interactive
education**



Digital learning



Vigor2110 Series

- 2 VPN Tunnels



Small business



Home-made bakery



Friend-shared apartment



Coffee shop



Home-based business



VigorFly 210



Music
Download



Movie
Download



Internet
Surfing



Multimedia
Applications

- Wi-Fi Router
- IPv6
- Parent Control



Internet

Fixed Line



DrayTek IP PBX Solutions



+



- IP Telephony
- Enhanced Security
- Better Productivity



DrayTek Soft Phone

- Support the ZRTP Key Agreement Protocol (RFC 6189)
- Be reachable wherever you go



VigorIPPBX 2820

- 50 IP Extension
- SIP/PSTN/ISDN Trunking



VigorIPPBX 3510

- 100 IP Extension
- SIP/PSTN/ISDN Trunking

Next Generation Access: VDSL2



Vigor2850 Series

VDSL2 with ADSL2+

Multi-WAN Load Balancing/Failover

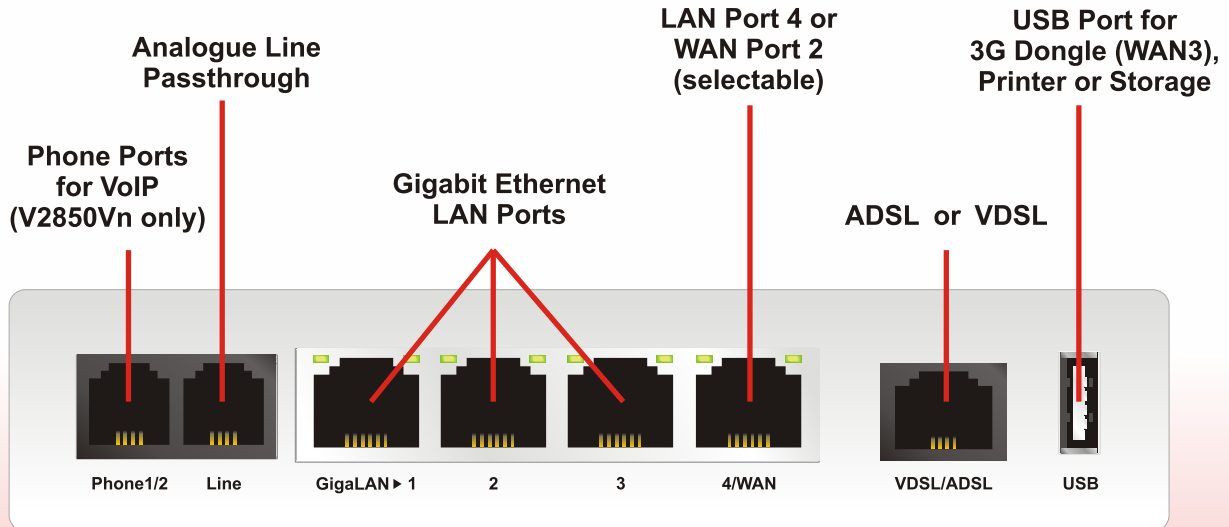

Vigor2760 Series

VDSL2 IAD

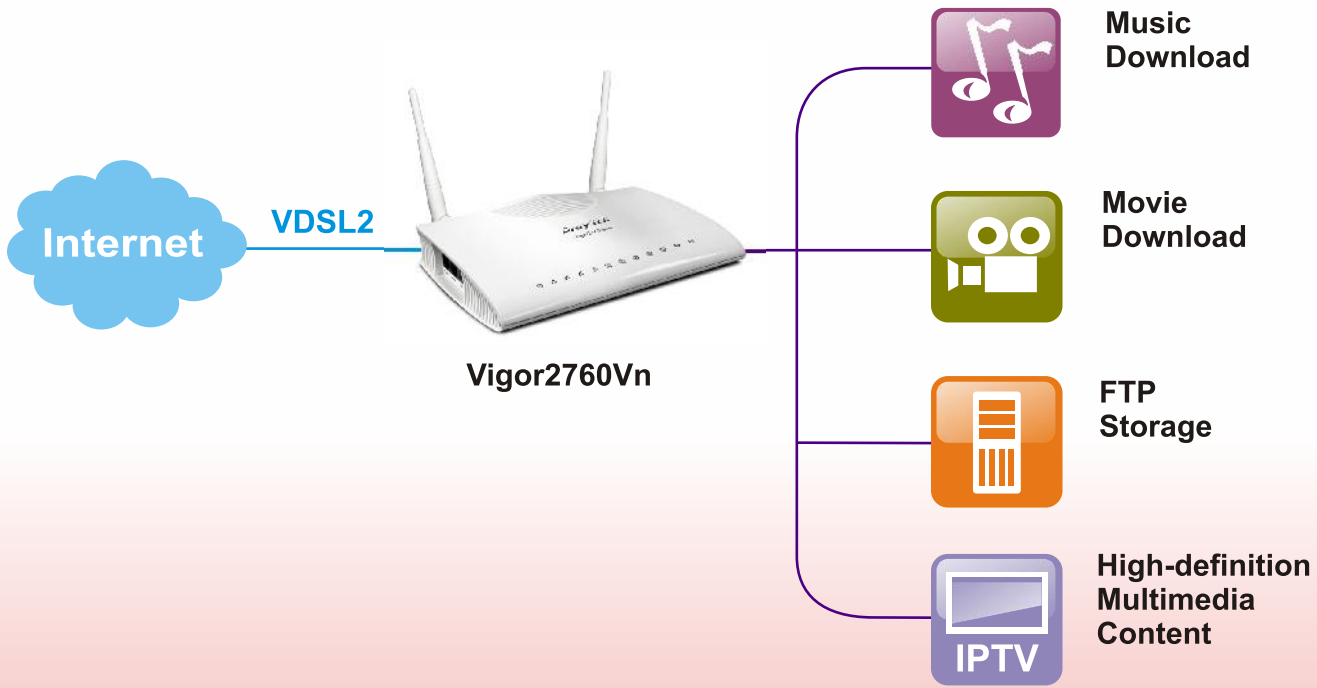

ADSL2/2+



Vigor2830 Series

ADSL2+ Security Router

Security & Firewall

Multi-WAN Load Balancing/Failover

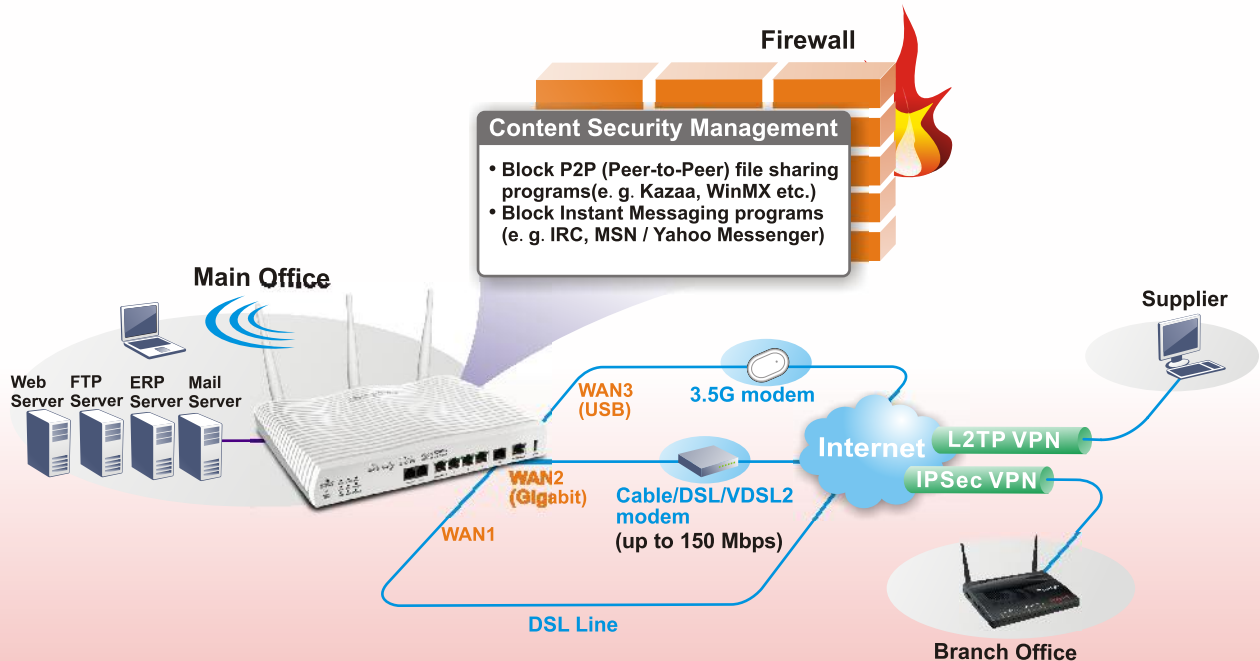

Vigor2710 Series

ADSL2/2+ Firewall Router

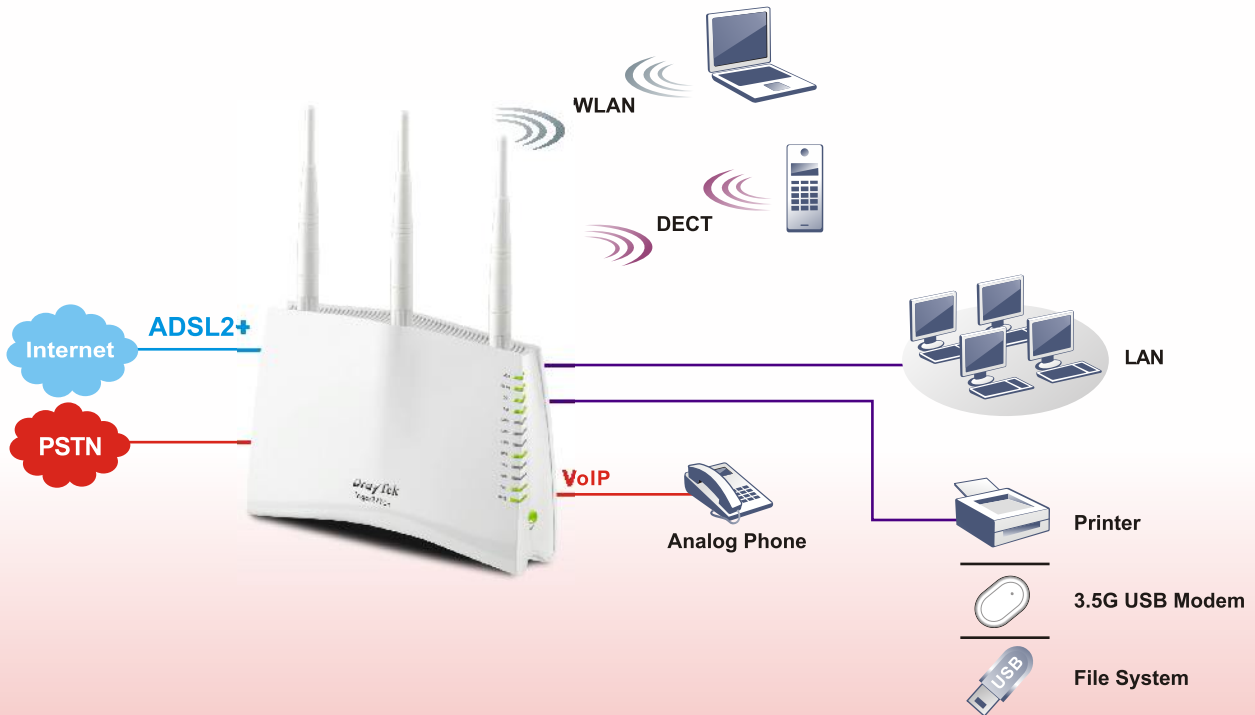

Vigor2710e/ne

ADSL2/2+ Router



Bee rancher



Florist



Farmer market



Hair designer



Dentist



Web Content Filter license key

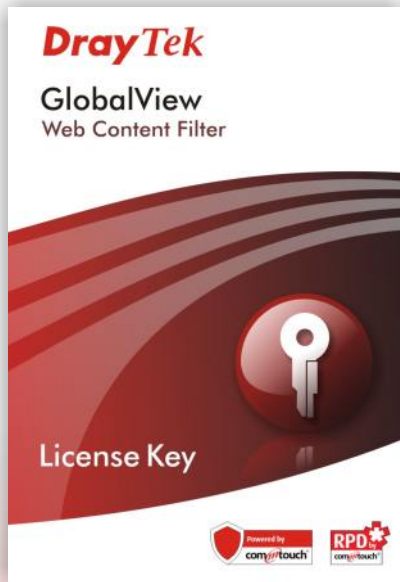

- Zero-Hour Security for identifying outbreaks on their way to users, instead of reacting to their pain.
- Innovative Data Cloud Technology for overcoming local storage limitations and satisfying customers' specific needs.
- Unparalleled Accuracy :
 - Customer-oriented classification triggered by every new site customers browse.
 - Routine analysis of site dynamics and user behavior determines scan granularity.
 - Continuous tracking ensures exact classification of each URL at every moment.



RADIUS Server on WLAN Access Point

WMM (Wi-Fi Multimedia, QoS for Wi-Fi multimedia streaming)



WDS

Multiple SSID

Wireless Restricted access list for clients (by MAC address)

VigorAP 800

Enterprise-level

WLAN Access Point

Integration of Vigor2830n WLAN and VigorAP 800

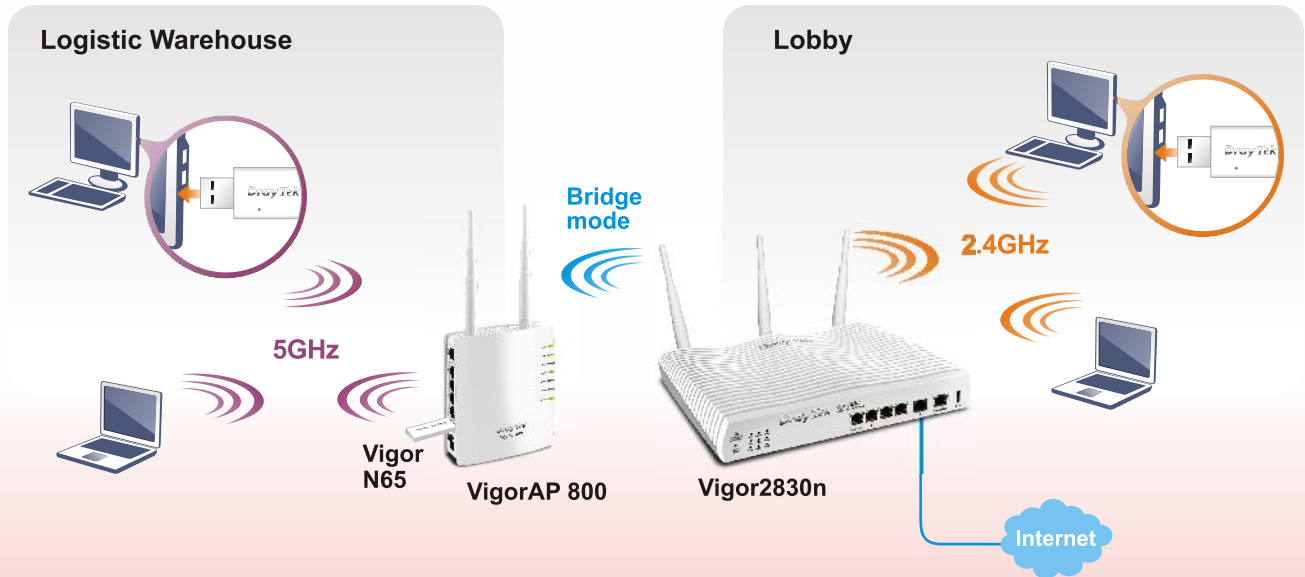

Note : Wireless performance always depends on your specific environment.
If your N65 connected to VigorAP 800, the WMM functionality is only working within 2.4GHz frequency.

VigorAP 700

SOHO-level

WLAN Access Point

Range Extended

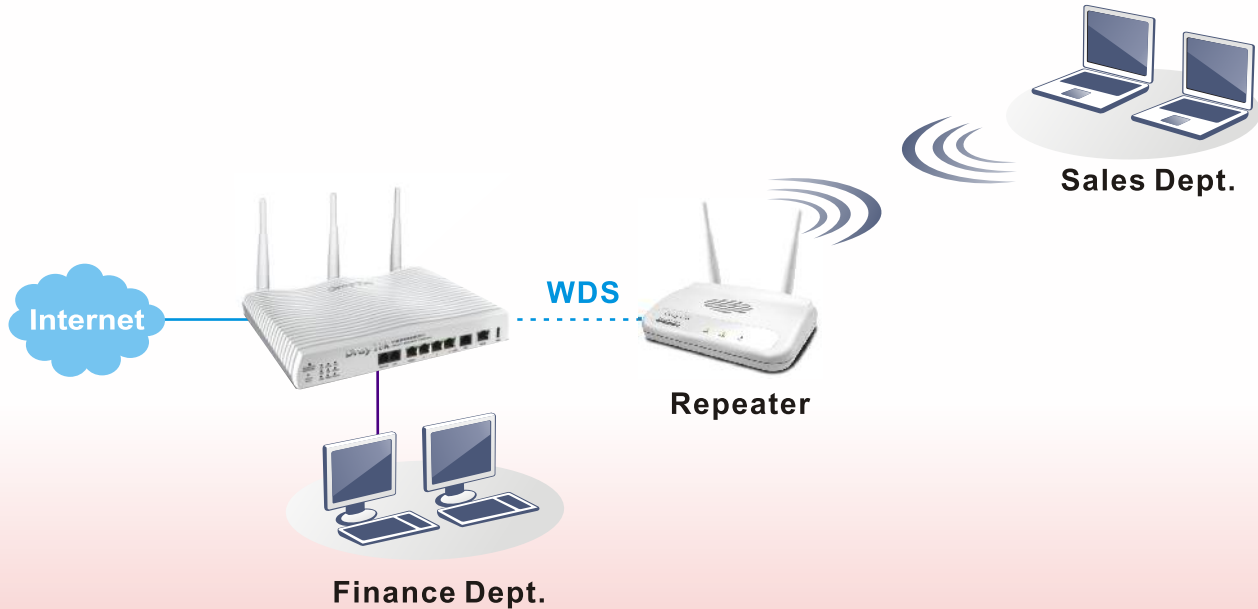

VigorSwitch P1080

8-Port PoE Ethernet Switch

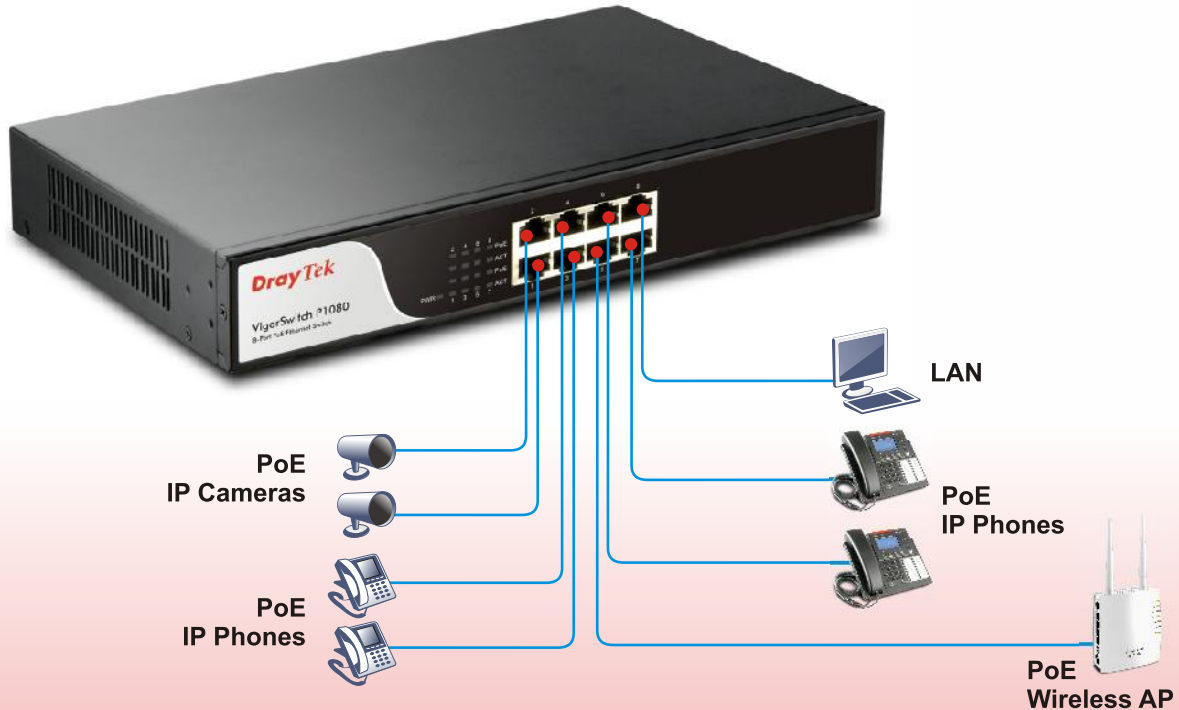

VigorSwitch G1240

24 Gigabit Port Web Smart Switch

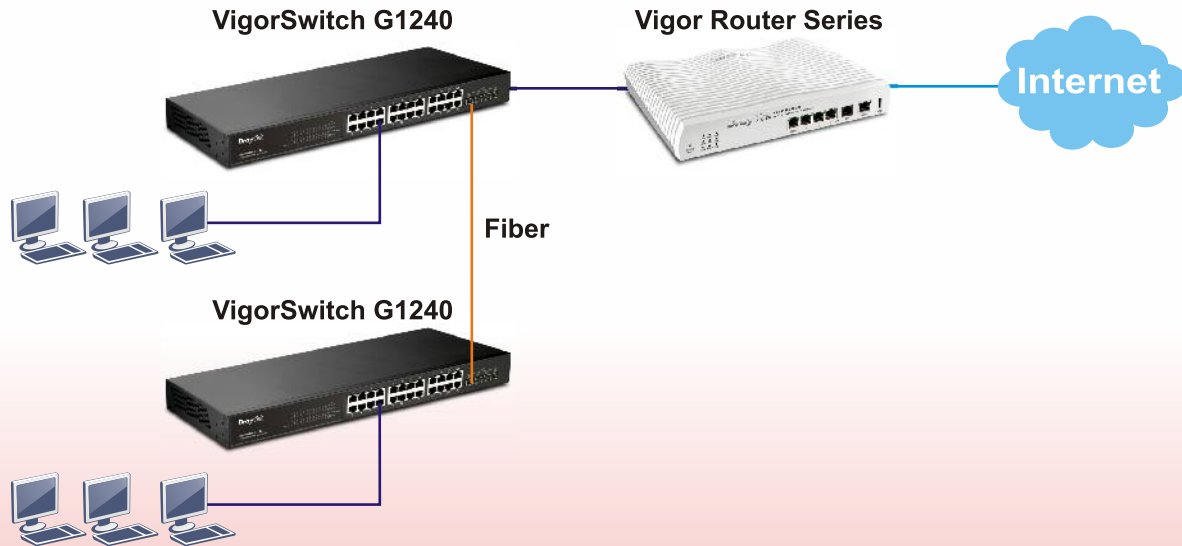

DrayTek *We deliver you*



More.... www.draytek.com

DrayTek

居易科技

IP PBX
Fiber Firewall
VPN Wireless xDSL
CSM VoIP
ISDN/S0 Multi-Play
Central Management



TAIWAN
EXCELLENCE
2011